

**oy!CHE**











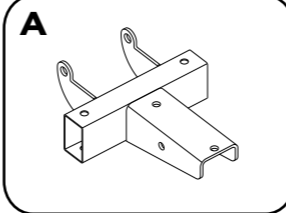
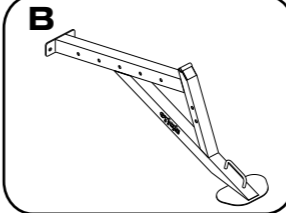
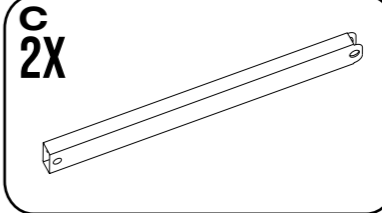
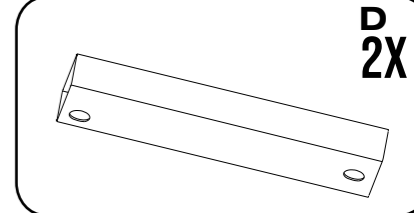
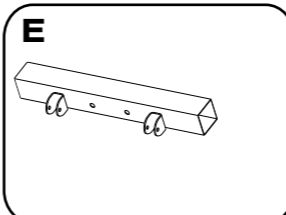
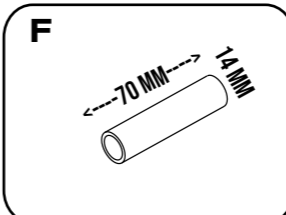
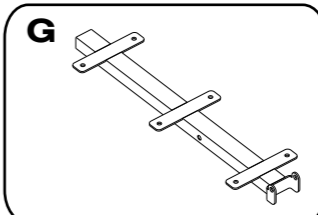

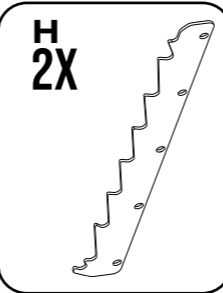
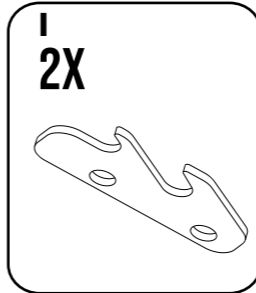
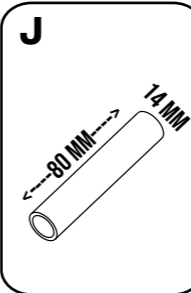
**OY006**

WERSJA: 22.01.24.15:13

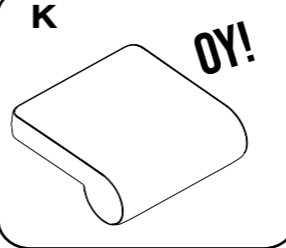
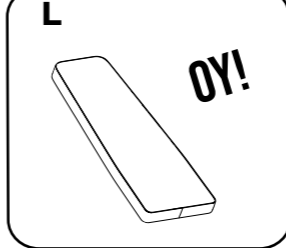
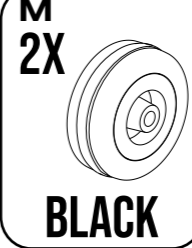
# LISTA ELEMENTÓW W ZESTAWIE

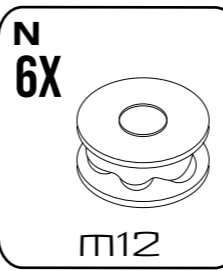
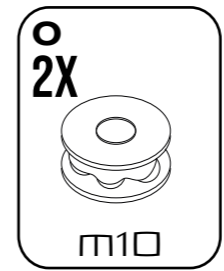
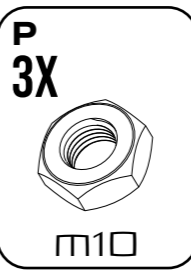
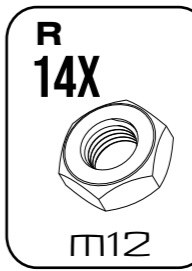
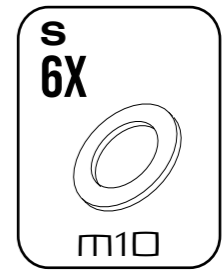
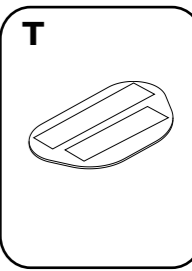
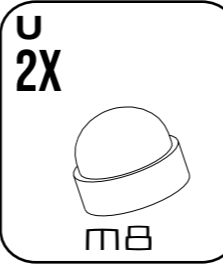
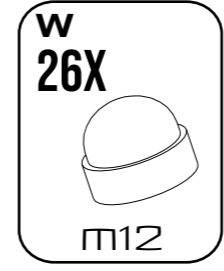
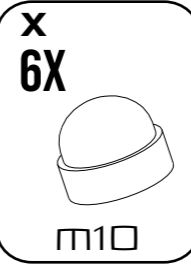
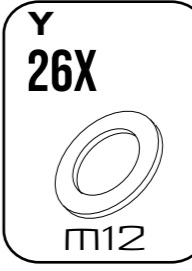
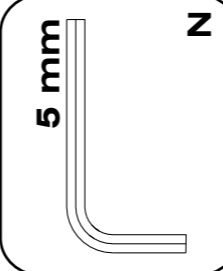
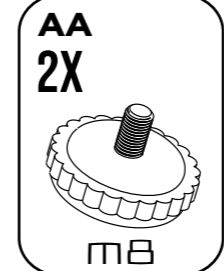
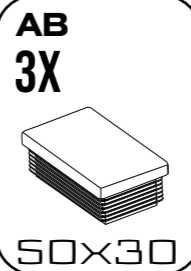
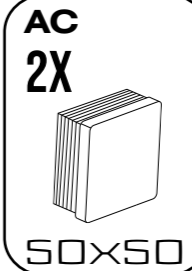
(Czegoś brakuje? Pisz na reklamacje@oyche.pl)

„Tam, gdzie nie ma walki, nie ma siły.”

<b>A</b> 	<b>B</b> 	<b>C</b> 2X 	<b>D</b> 2X 	
<b>E</b> 	<b>F</b> 	<b>G</b> 		M8 25 MM  8X AD
				M8 70 MM  2X AE
<b>H</b> 2X 	<b>I</b> 2X 	<b>J</b> 		M10 120 MM  1X AF
				M10 140 MM  2X AG
				M12 120 MM  2X AH
<b>K</b>  OY!	<b>L</b>  OY!	<b>M</b> 2X  BLACK		M12 75 MM  9X AI
				M12 60 MM  X2 AJ
<b>N</b> 6X  M12	<b>O</b> 2X  M10	<b>P</b> 3X  M10	<b>R</b> 14X  M12	<b>S</b> 6X  M10
<b>T</b> 				
<b>U</b> 2X  M8	<b>W</b> 26X  M12	<b>X</b> 6X  M10	<b>Y</b> 26X  M12	
<b>Z</b> 5 mm 	<b>AA</b> 2X  M8	<b>AB</b> 3X  50X30	<b>AC</b> 2X  50X50	
				<b>BĘDZIESZ POTRZEBOWAŁ</b> 13 MM  17 MM  2X 19 MM  2X

1

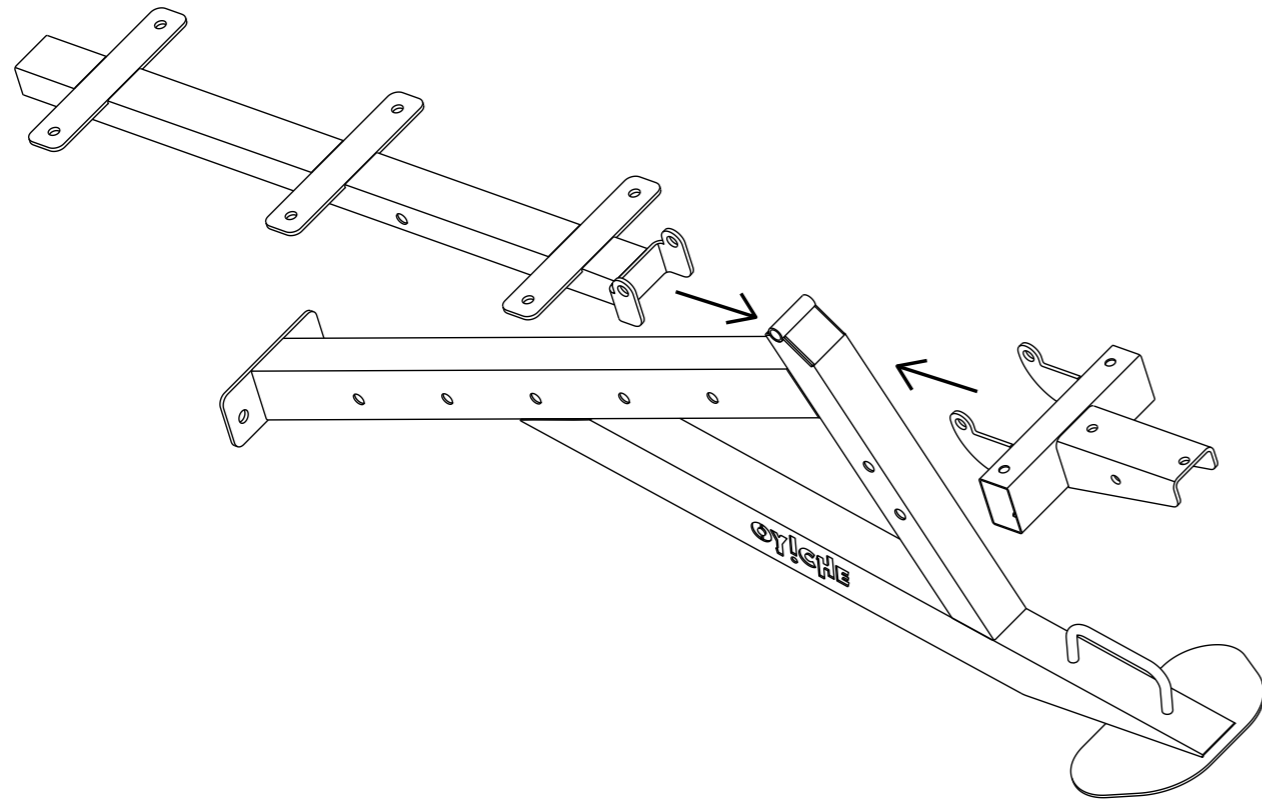

- 

M12 120 MM 1X AH
- 

N 12 MM 4X
- 

Y 2X m12
- 

R 1X m12

2

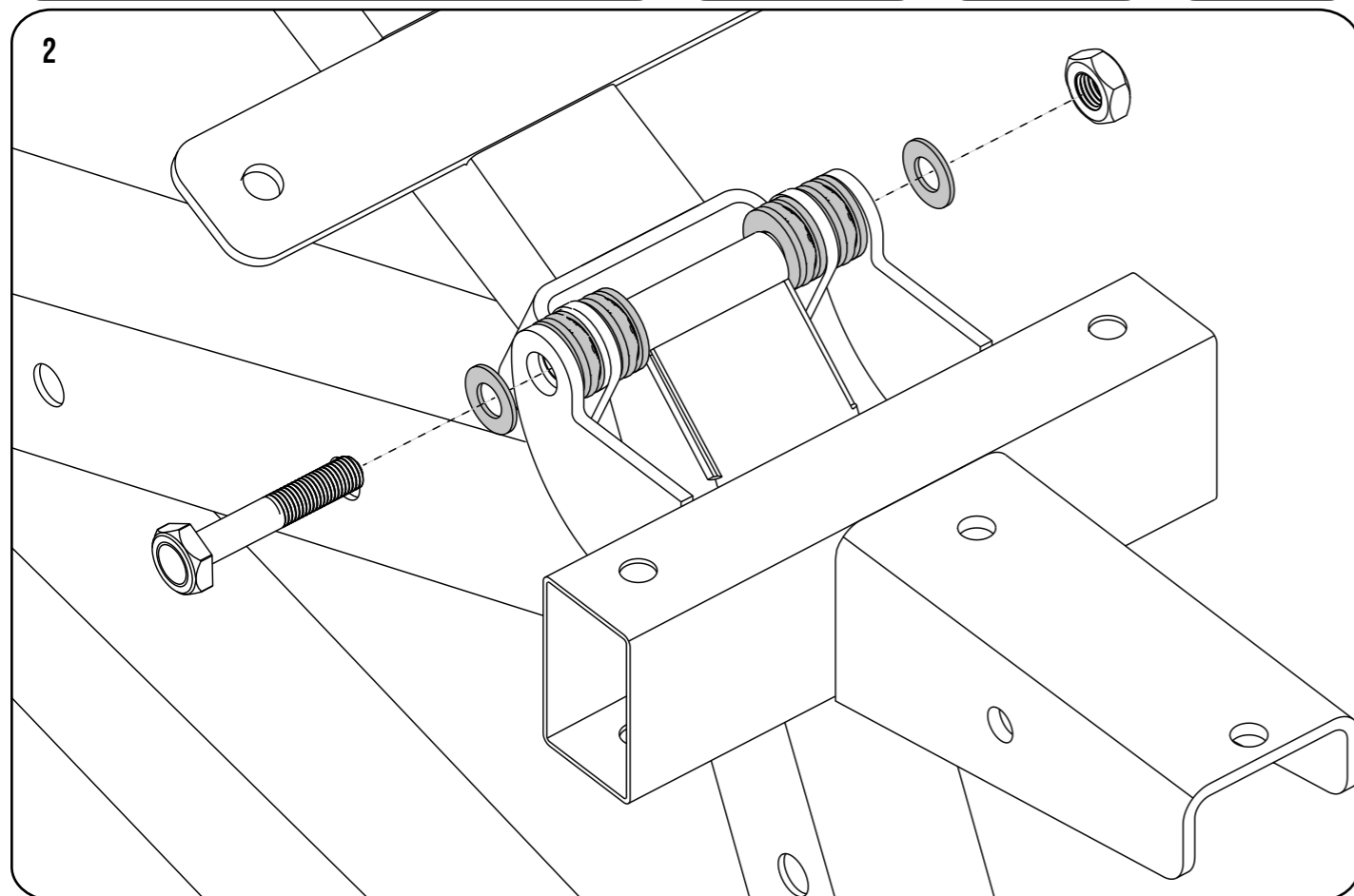

4

3

Pamiętaj o odpowiednich podkładkach pod każdą ze śrub oraz odpowiednich nakrętkach.

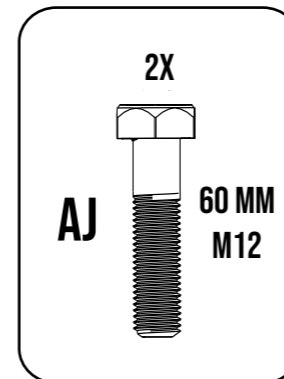
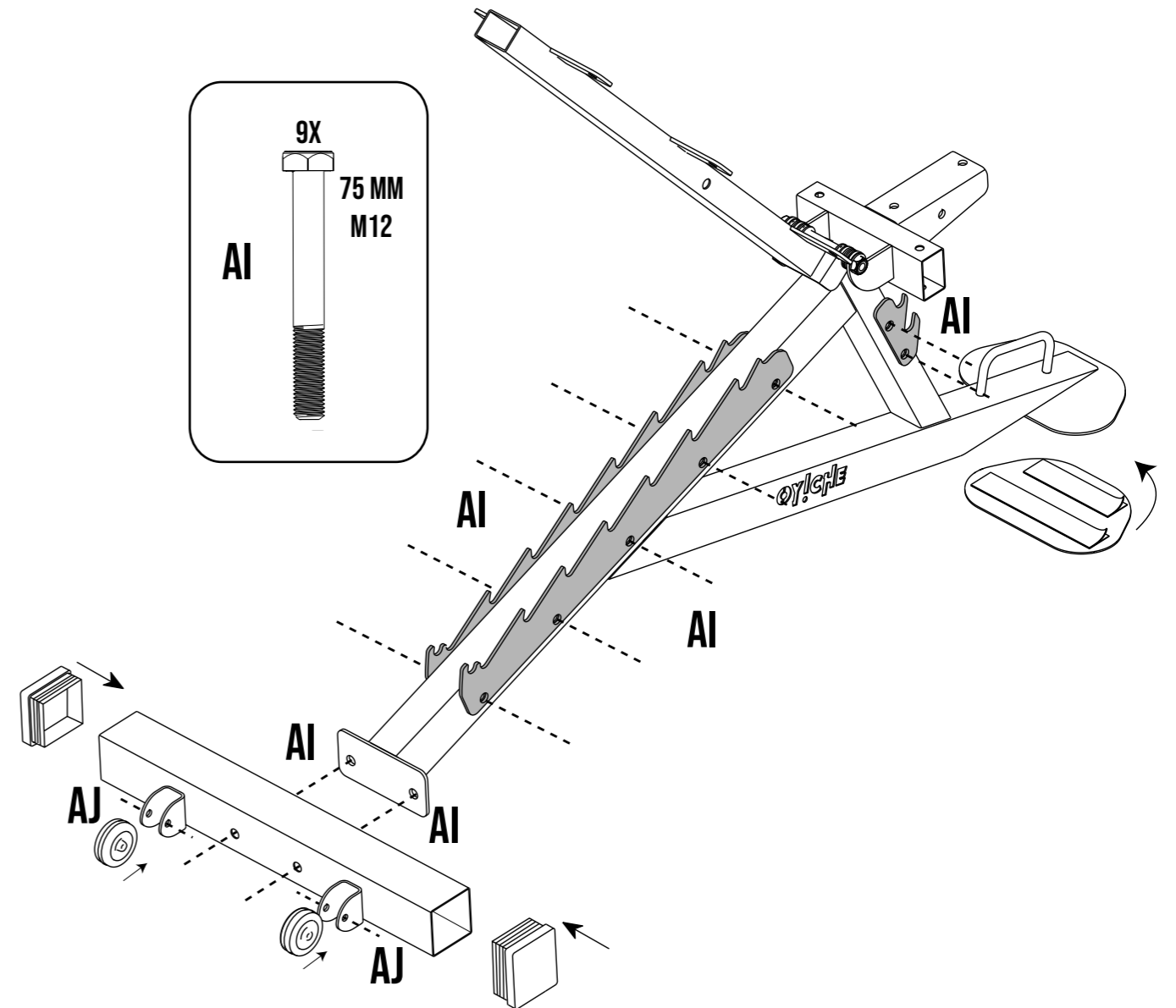
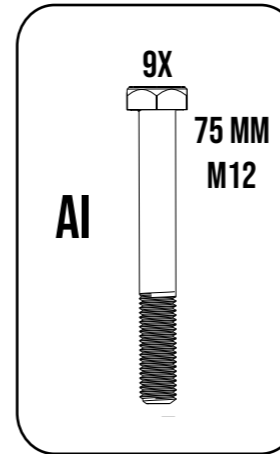
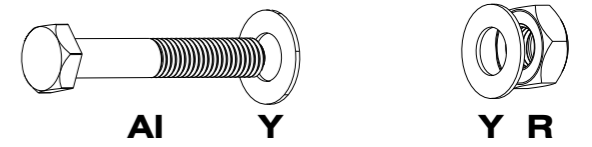

5

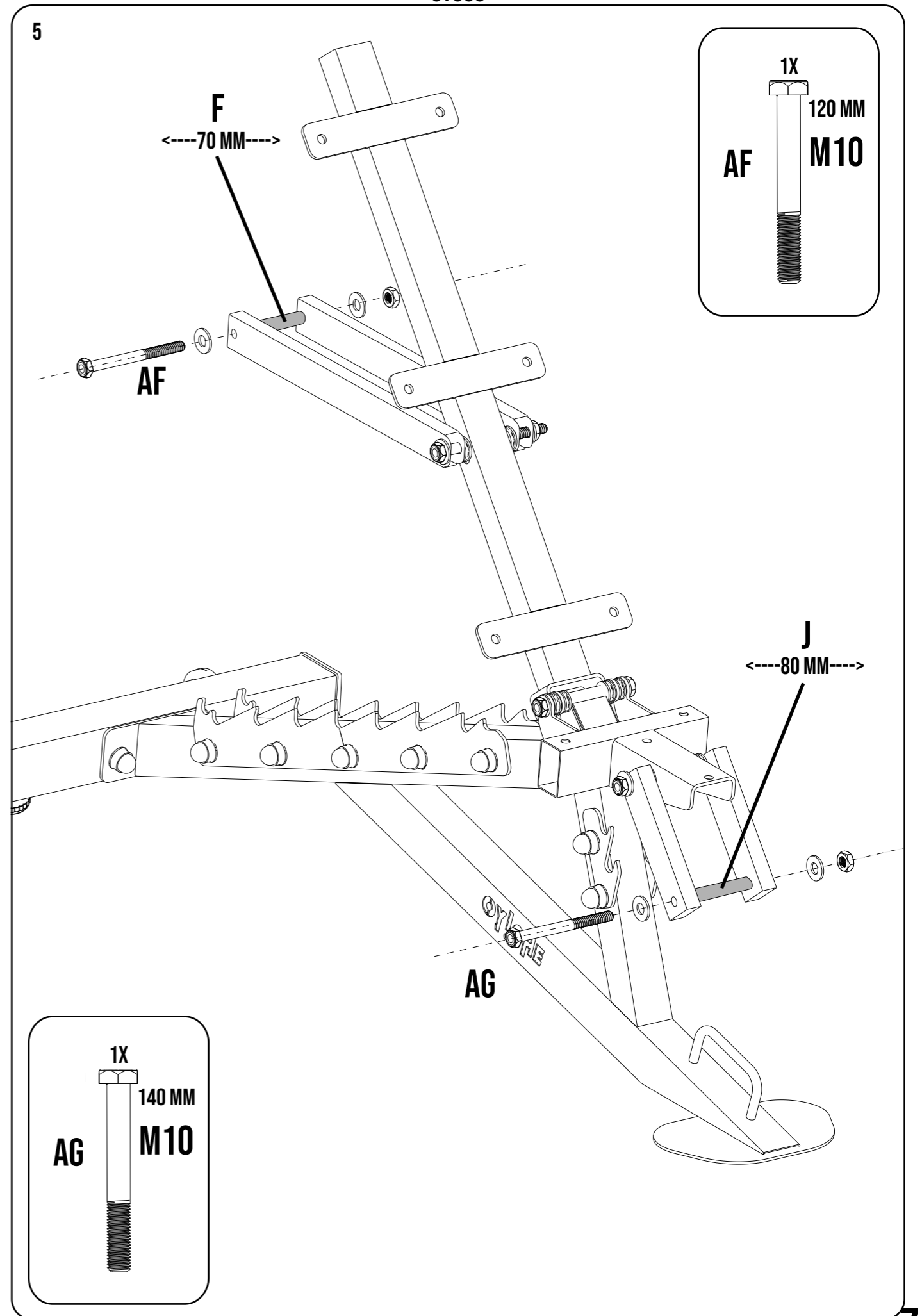
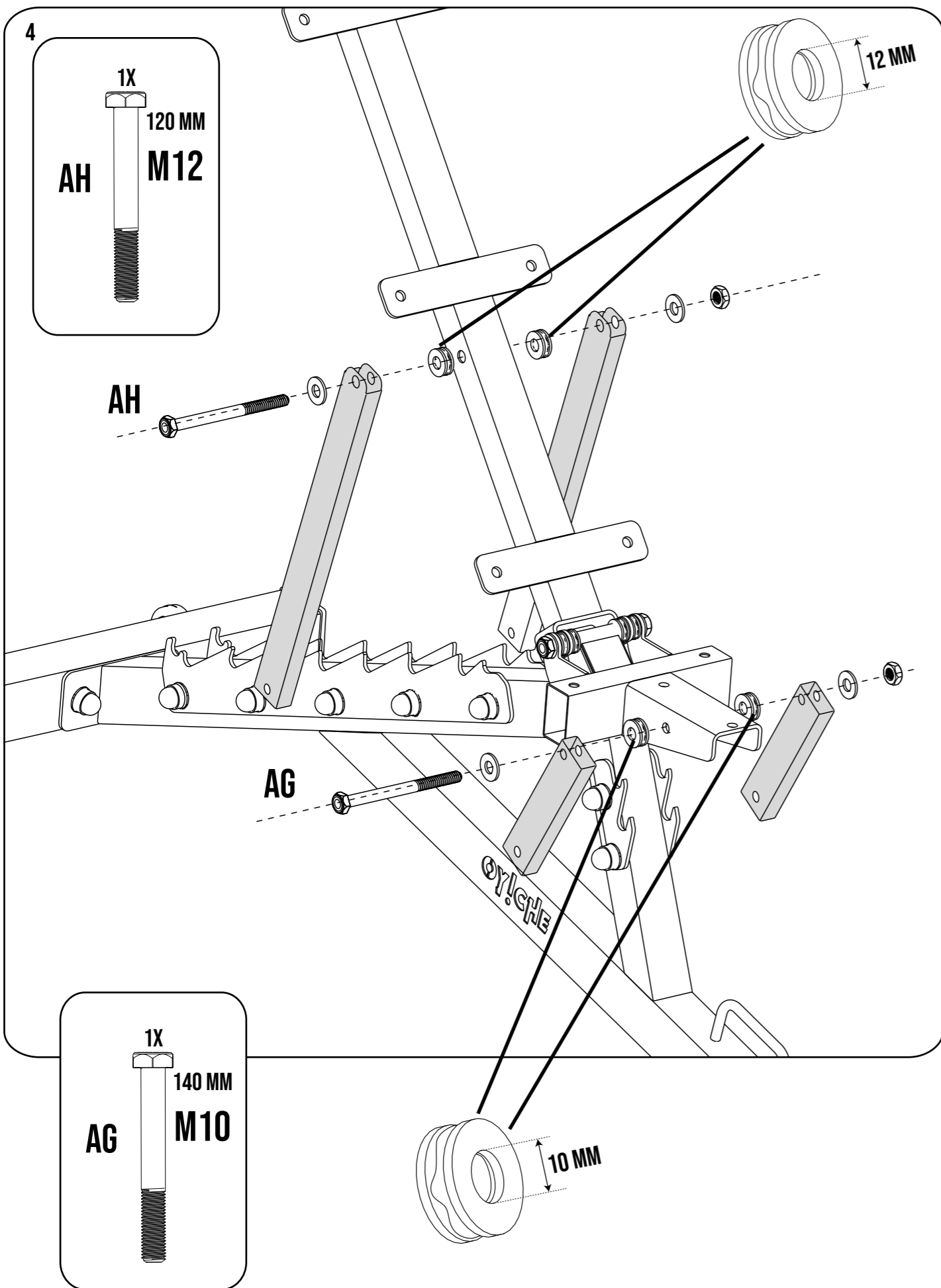

OY006

6

25 MM  
**M8**  
 6X  
**AD**

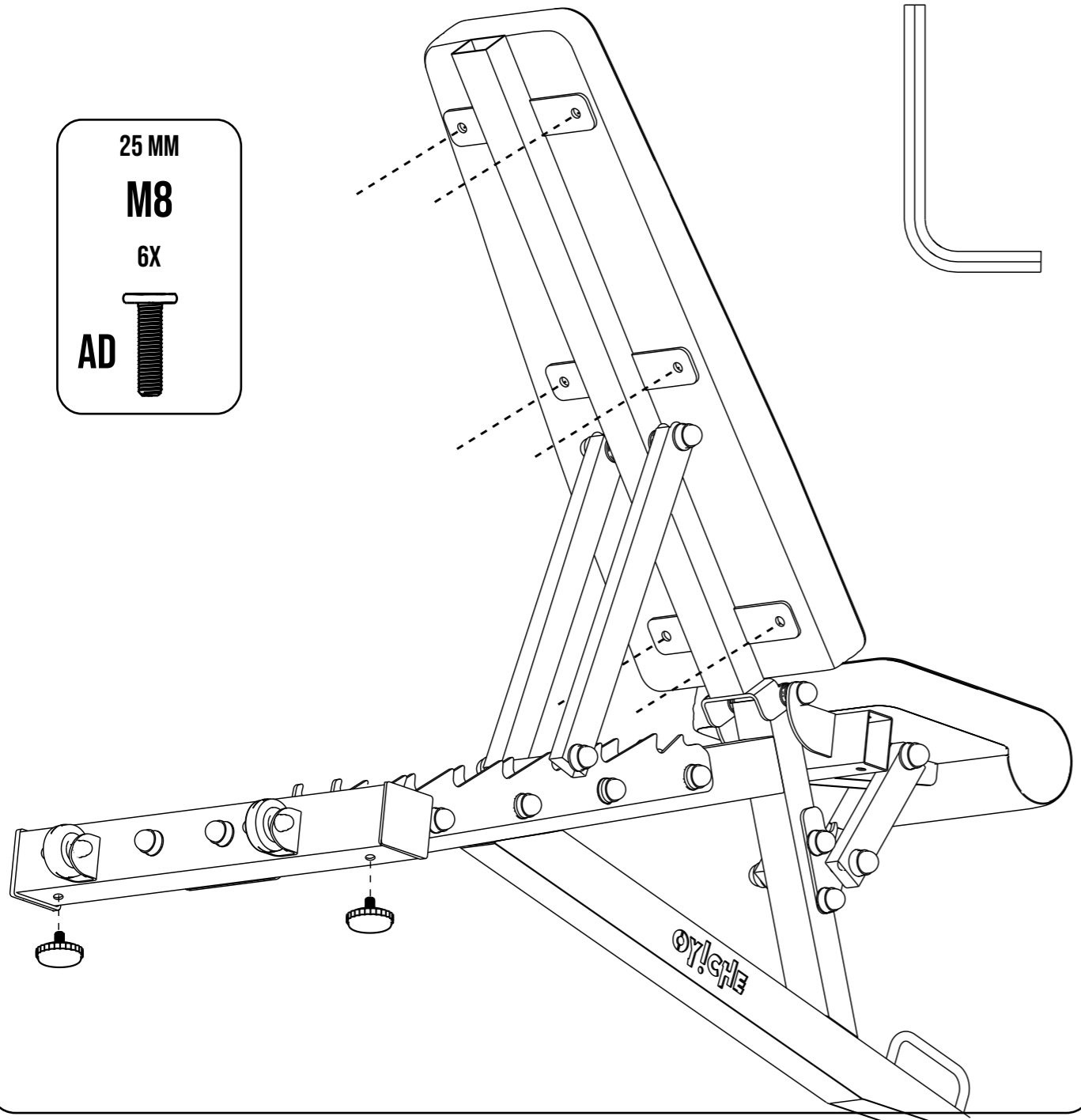

OY006

7

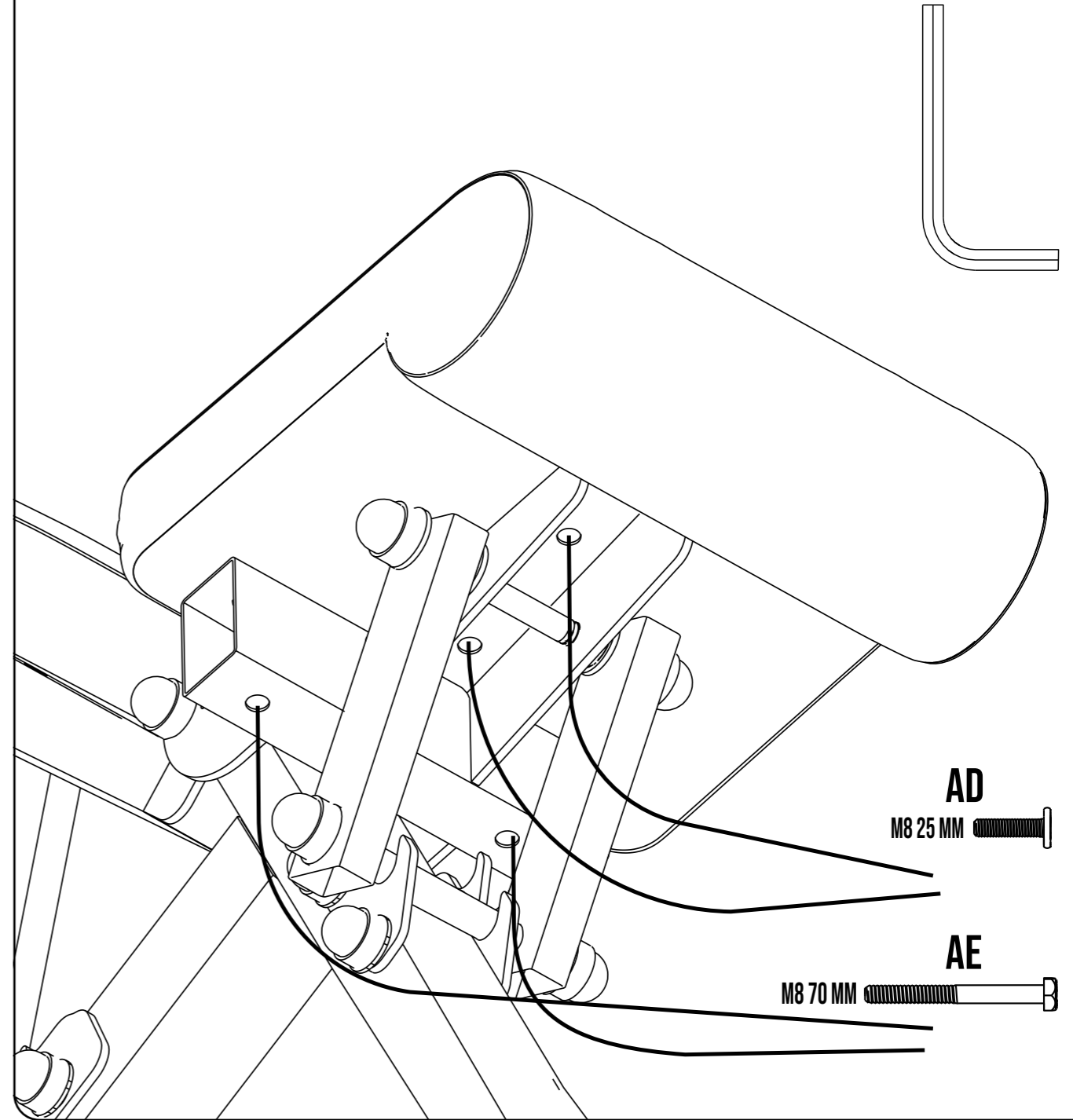

8

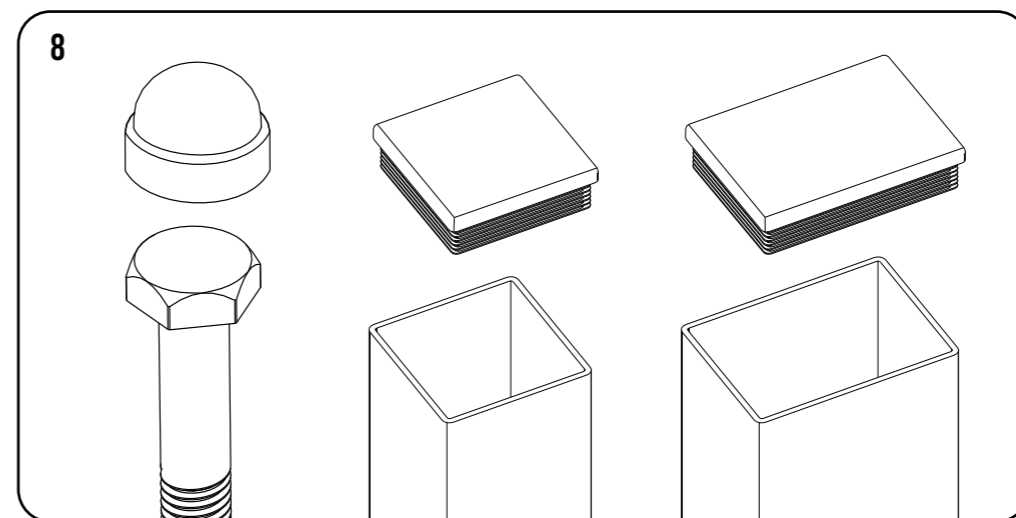

9